



Reimagining Architecture with FRP Composites

Samer Aljishi,

Ph.D.,

Group President, BFG International

- 
1. Introduction
 2. Why composites for Architecture
 3. Review of Landmark Global FRP Composites in Architecture
 4. HCB – Innovative use of Composites in Infrastructure
 5. Design Considerations
 6. Review of Fire Compliance with modern Composites.
 7. Review of Structural Durability with Modern Composites
 8. Review of Safety with Modern Composites
 9. Review of Sustainability with Modern Composites
 10. Conclusions



Introduction

For thousands of years, humanity designed buildings in this way:

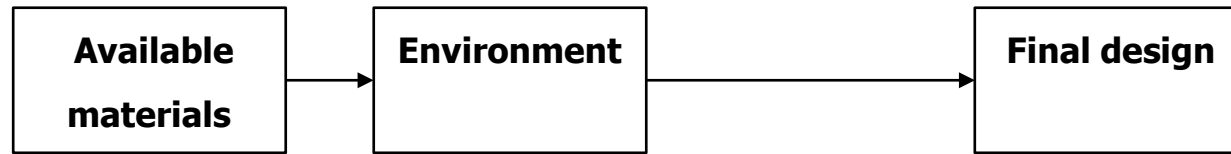

Example:



In this design, the buildings are made with local available materials. Cool air enters into the buildings through wind towers to provide local cooling internally.

The buildings are built close together and the open spaces are protected from sunlight.

At present, due to the transfer of knowledge and globalization, the design of buildings is mostly done in this way:

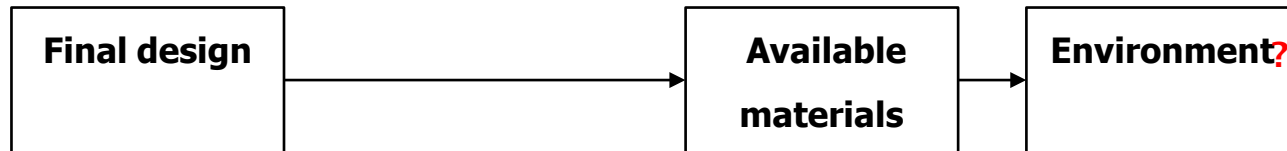

Frequently, buildings are made without considering resources and the environment. Generic Building Designs.





COMPOSITES

AN INFINITE WORLD OF
POSSIBILITIES

TODAY, THERE IS A BETTER WAY TO MAKE THINGS

The world of FRP composites is more than another material option. Composites are a forward thinking, high strength, innovative materials that offer the flexibility to dream and think big to make ideas a reality.

SHAPING THE FUTURE OF ARCHITECTURE

EXPLORE OUR WORLD OF INFINITE POSSIBILITIES

There is a future where buildings are made better, lighter, more efficient, more durable, more creative.





Why composites for Architecture

Mechanical Properties of typical Architectural FRP Composites vs. Concrete Building Materials

- Most Structural Applications like Roofs and Façades need to have long spans between supports. The high **tensile and shear properties** of FRP lend well for such applications.
- The **low density** at high strength make FRP the best choice in terms of weight per m2 imposed on the building.
- The significantly **lower thermal conductivity** of FRP is a major advantage for sustainability due to lowered heat load.
- The very **low porosity** of FRP is an excellent characteristic for outdoor applications under inclement weather.

Characteristics	FRP	Concrete	UHPC	GFRC
Tensile strength (MPa)	220	4	7	7
Flexural strength (MPa)	220	5	30	22
Compressive Strength (MPa)	90	30	200	50
Shear strength (MPa)	12	3	9	4
Elasticity modulus (GPa)	21	20	50	15
Density (kg/m ³)	1800	2300	2450	2000
Thermal conductivity (W/m C)	0.57	2	4	1.2
Thermal expansion (10E-5 m/m C)	2	5	5	3
Porosity (%)	0	30	3.5	20



STRUCTURES WITH UNIQUE AESTHETICS

FRP structures can take on almost any **surface** form: flat, double curved, fluted, ribbed and contoured into a whole variety of shapes, with surfaces moulded to an extensive range of **colours, textures and finishes**, from smooth to stone, glossy to matt, pebbly and even metallic like chrome and gold.



HIGH STRENGTH TO WEIGHT RATIO

FRP products can provide a range of strength and stiffness for diverse applications, from home use, all the way to airplanes. FRP structures achieve the required strength at much lower weight compared to concrete, steel and aluminium – as low as **25-30%** of weight of **steel** or **30-40%** of reinforced **concrete**.



DURABILITY AND LOW MAINTENANCE

Composites structures are **corrosion free**, don't rust and have a **long lifespan** with little or no maintenance. Structures build by BFG are in excellent condition and performing as new after 35 years in service.



PARTS CONSOLIDATION

Built in **large forms** with **few joint** lines, there is a lower risk of failure and leakage. This is not possible with metallic or concrete materials without high costs in tooling.



EASE OF INSTALLATION

Lightweight composites are quicker to install and require less structural supports. Panelling size is limited only by transport and the number of joints can be reduced for **quicker, safer, greener** and **simpler** assembly.



LONG TERM COST SAVINGS

Owners achieve **cost savings** with **lower foundation** costs and faster installation, reducing equipment and management overheads. In addition, with less maintenance, composites reduce total life cycle cost and contribute positively towards **reducing environmental impact**



LIGHT TRANSMISSION

FRP can be moulded using resins that give **translucence** to skin surfaces, a unique property amongst structural materials



HIGH DIELECTRIC STRENGTH

FRP composites have excellent **electrical insulation** properties, making them ideal in applications where electric current can come in contact with part of the product, with FRP working as **insulator** for user safety.



HEAT INSULATION

FRP composites are **inherently good heat insulators** and therefore excel in applications including window trims, door skins, roofing and exterior cladding. Inherently providing **energy savings** from heating or cooling.



Review of Landmark Global FRP Composites in Architecture

Al Bayan School- Bahrain (1982)



**Composite
Structure
External
Building Walls
for Al Bayan
School -
Completed 1982**



SAFE AND ENVIROMENTALLY FRIENDLY COMPOSITES SOLUTION

- **Light weight modular composite panels offered fast assembly**
- **Assembly made possible with light lifting equipment and done safely.**
- **The shading façade contributed very positively towards reducing air conditioning cooling requirements**
- **No supporting steel structure was required – resulting in a lower carbon footprint for the overall installation**
- **Maintenance Free – Has not been painted or maintained in 38 years since install**



FRP Segmented composite dome - 25-meter diameter with simulated stone external finish and Internal Decorative Panels

Built on Reclaimed Land. Dome weight 30 Tons versus original stone clad dome design weighing 150 Tons

Dar Al Handasah Architects (1984 - 1986)

SAFE AND ENVIROMENTALLY FRIENDLY COMPOSITES SOLUTION

- The original design was for a simulated stone dome weighing 150 Tons.
- The Composites Lightweight dome came in at 30 Tons
- The result was a massive saving in Concrete Foundations and Steel Foundation Piles contributing massively towards a greener footprint for the project and vastly reduced overall costs.
- Installation at site was completed very quickly due to the large monolithic light weight nature of the composite dome design. The elimination of need for specialized masons working at elevated height for an extended period of time was a major contributor to project safety.
- The composite dome has required zero maintenance for the past 36 years – no leaks, cracks, corrosion or environmental discoloring. All of this again contribute very positively to reduced environmental impact.

University of Amsterdam – Faculty of Science (2007)



Interior and Exterior panels at Amsterdam University (Netherlands)



SAFE AND ENVIROMENTALLY FRIENDLY COMPOSITES SOLUTION

- Compared to Pressed Aluminum Panels, the only other alternative to the Composites solution , the fiberglass panels eliminated the need for expensive and heavy press steel moulds and had a much lower carbon footprint due to the lower energy costs required in manufacturing both the constituent materials and fabricating them.
- Panels supplied are very impact resistant and do not dent and need to be replaced during the lifetime of the building.
- Composite panels supplied fully conform to strict safety and fire norms applicable in the Netherlands
- The composite panels are light weight and very fast and safe to install.

36,500 square meters of 32 m x 6 m doubly curved structural FRP Façade Panels supported at 16-meter spans.

360 Architects (HOK) + Thornton Tomasetti (2010 - 2013)

Basra Sports Stadium (Iraq)

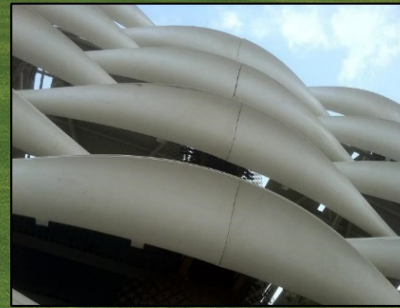
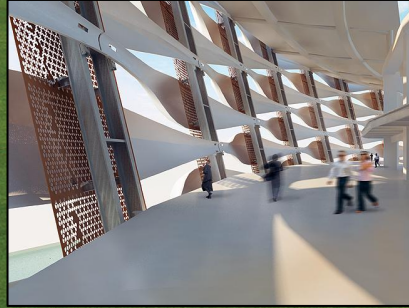

SAFE AND ENVIROMENTALLY FRIENDLY COMPOSITES SOLUTION

- **Designed as Easily Installed Monolithic and yet Large composite cladding panels in parametric curves which can be easily molded.**
- **Weight of each panel – approximately 25 kg per sq M**
- **Only five different moulds were used to make the 288 panels**
- **Because of their inherent structural strength at light weight, the panels needed to be supported only at four points on steel columns. Reducing massively the need for an extensive secondary steel structure and thus contributing towards a green design philosophy.**
- **Designed for sea facing wind loads and seismic loads.**
- **Fire retardant to meet Class 1 surface spread of flame in accordance with BS476**
- **Zero maintenance at site during the life cycle**
- **Can be easily repaired or replaced at site if damaged.**

Haramain High Speed Rail Station (HHR)-KSA (2015)



Haramain High Speed Rail Station (HHR) - King Abdullah Economic City KSA

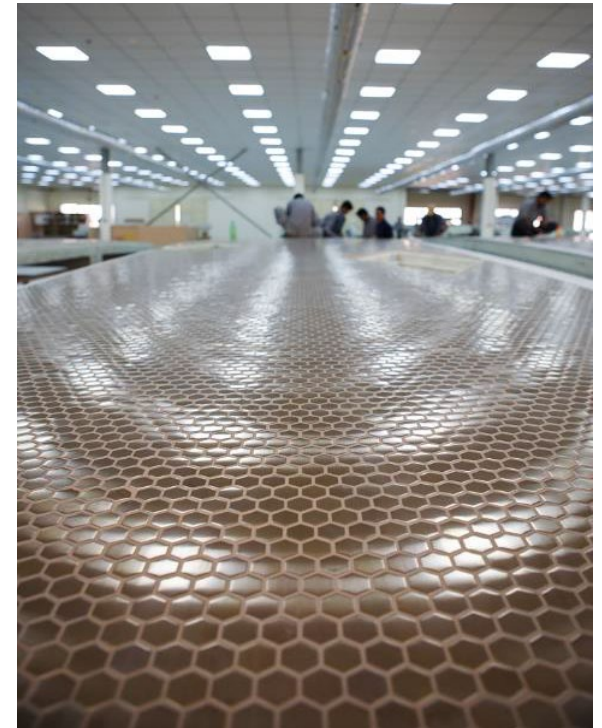
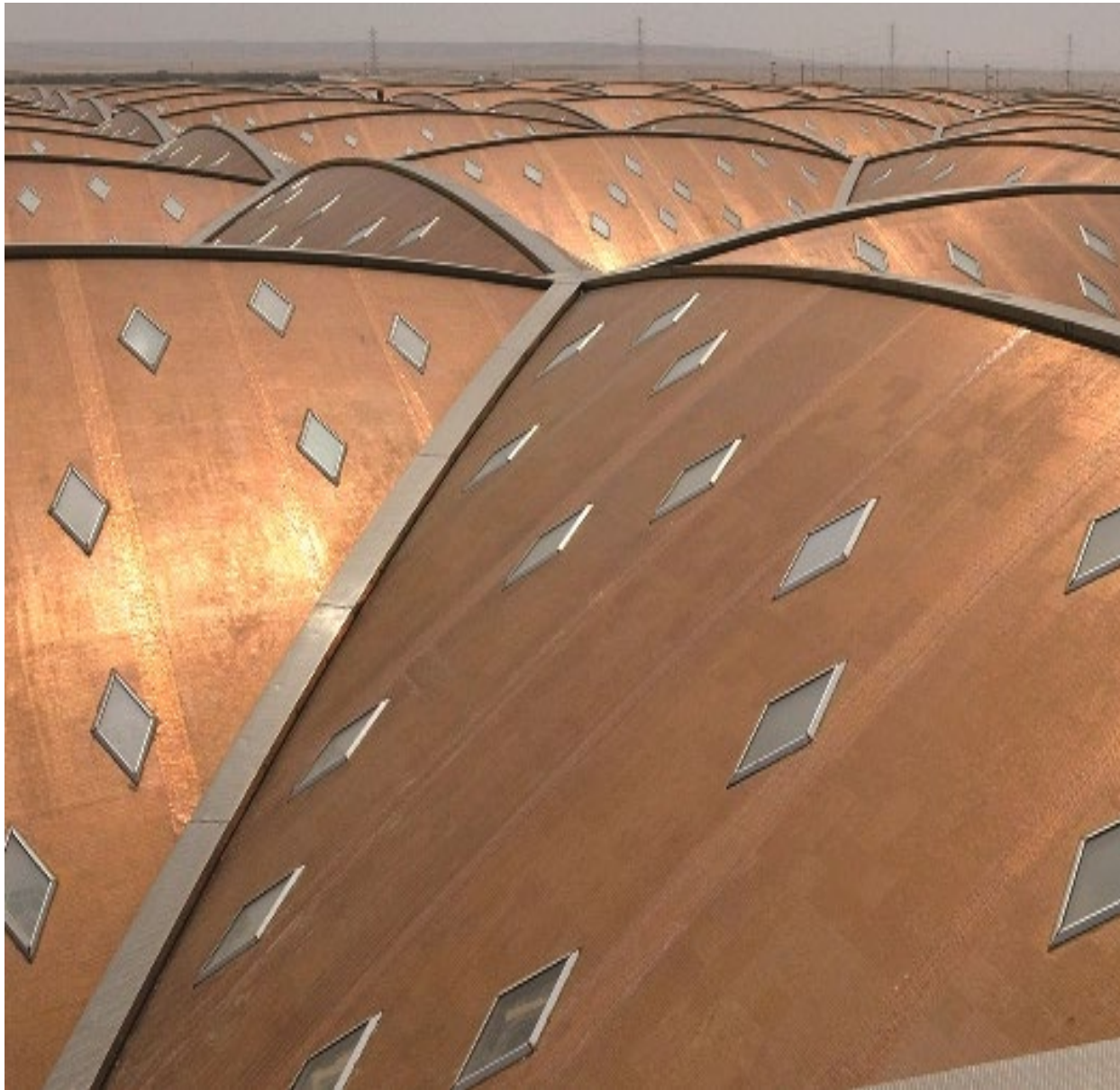

SAFE AND ENVIROMENTALLY FRIENDLY COMPOSITES SOLUTION

- Light weight structural long span composite panel molded in epoxy resin system with PET foam core
- Light Weight – at approximately 30 kgs per sqm
- High thermal insulation in-built as part of the panel construction with foam core sandwich construction.
- Daylight glazing incorporated in the composite panel design
- Aluminum ceiling suspended from composite panel
- Easy to handle and install at site in very short time
- Savings on steel structures due to light weight

San Francisco MOMA Refurbishment Façade

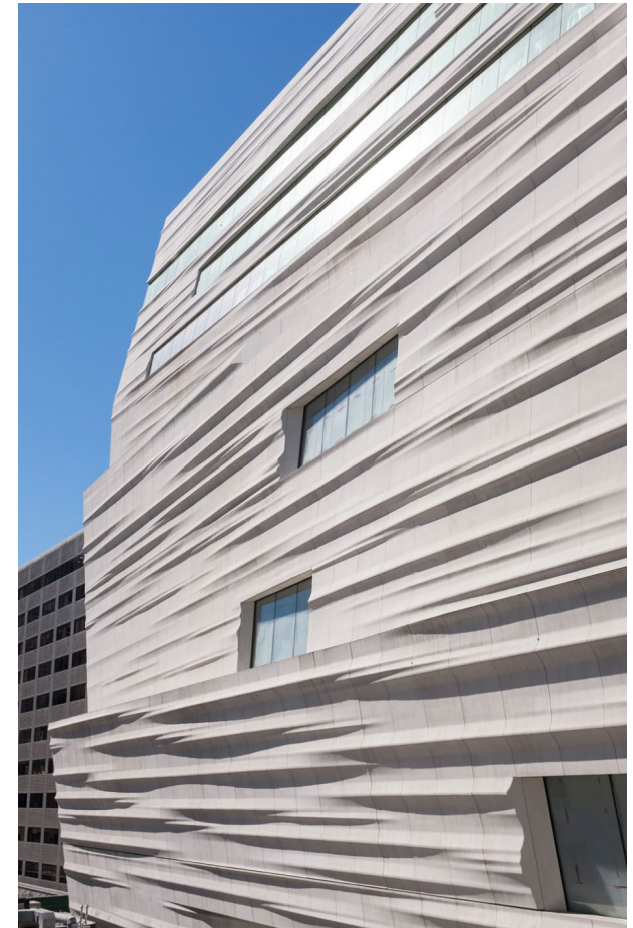

Architect Snohetta, 2016

Stedelijk Museum - Amsterdam (Netherlands)



Bentham Crouwel Architects and ARUP (2012)

Heydar Aliyev Center (Baku) - Azerbaijan



18,000 Square meters of double curved FRP Façade Elements with an average size of just over 1 sqm each.

Zaha Hadid Architects (2007 - 2012)

Marina Bay Sands Art and Science Center - Singapore



FRP panel claddings supported over a diagrid structure in the shape of a Lotus Flower.

Safdie Architects and Parsons (2007 - 2012)

Apple - Steve Jobs Theater in Cupertino (2017)

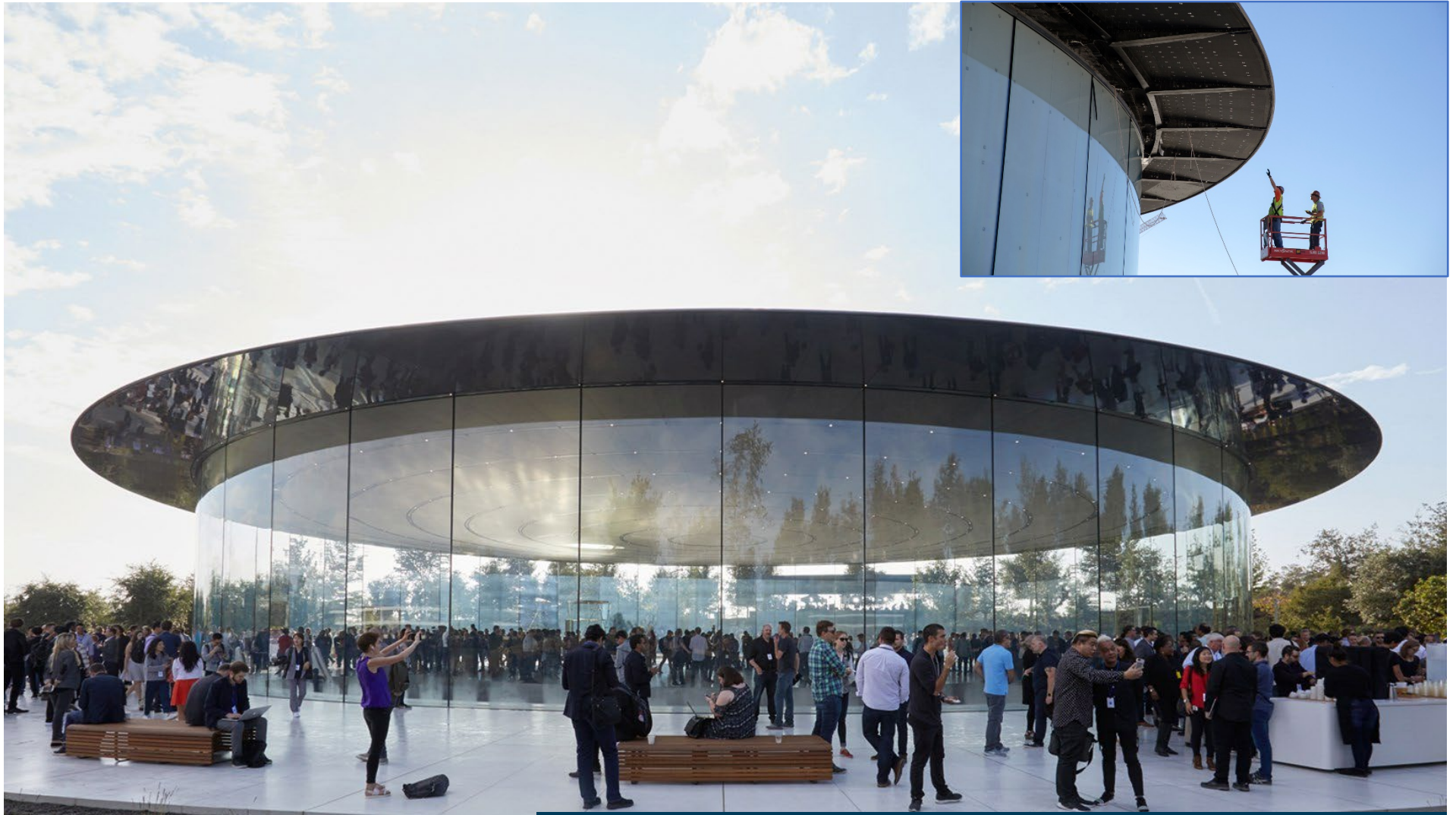

Architect Foster+Partners

Museum of the Future - Dubai UAE (2017)



Architect : Killa Design

Dior Store (Korea)



ARCHITECT: Christian de Portzamparc

Swanton Square (Australia)

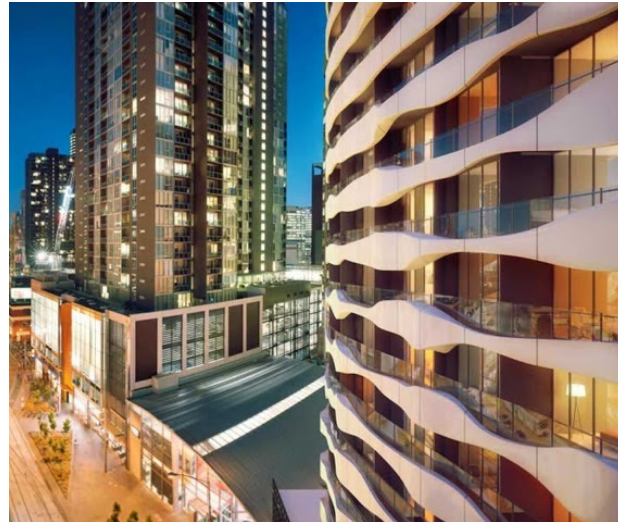
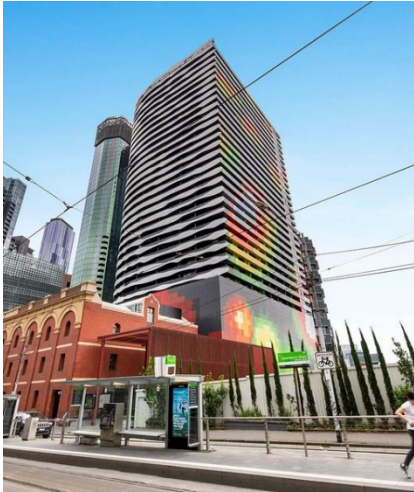

New SABIC Headquarters (2021)



KOLON Building (Korea)

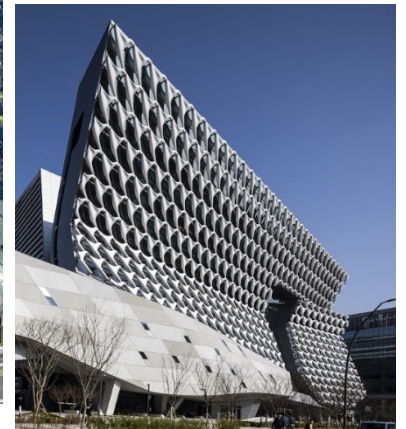



World Trade Center in KAED,
Riyadh - KSA

47,000 Square Meters of FRP
cladding for a 63 story tower
in Riyadh, KSA. NFPA 285
Fire Compliant.

Composed of 3180 Bespoke
Structural FRP Panels ranging
from 8 to 14 meter Spans.

Gensler + Buro Happold +
Permasteelisa (2015)

Station Building Envelopes (Doha) - Qatar



Complete Metro Rail Station Building Envelopes for 4 Elevated Stations and over 60 Entrance Shelters. Composed of double curved FRP Panels with a simulated Stone Finish covering a total roof area of over 220,000 square Meters.

Qatar Rail (2015 - 2018)



Avenues Mall - Kuwait

Large Span FRP Chrome
Reflective Finish Suspended
Light Weight FRP Ceiling
Panels measuring 27 m x 18 m
each.

Gensler + Pace (2016 - 2017)



HCB - Innovative use of composites in infrastructure

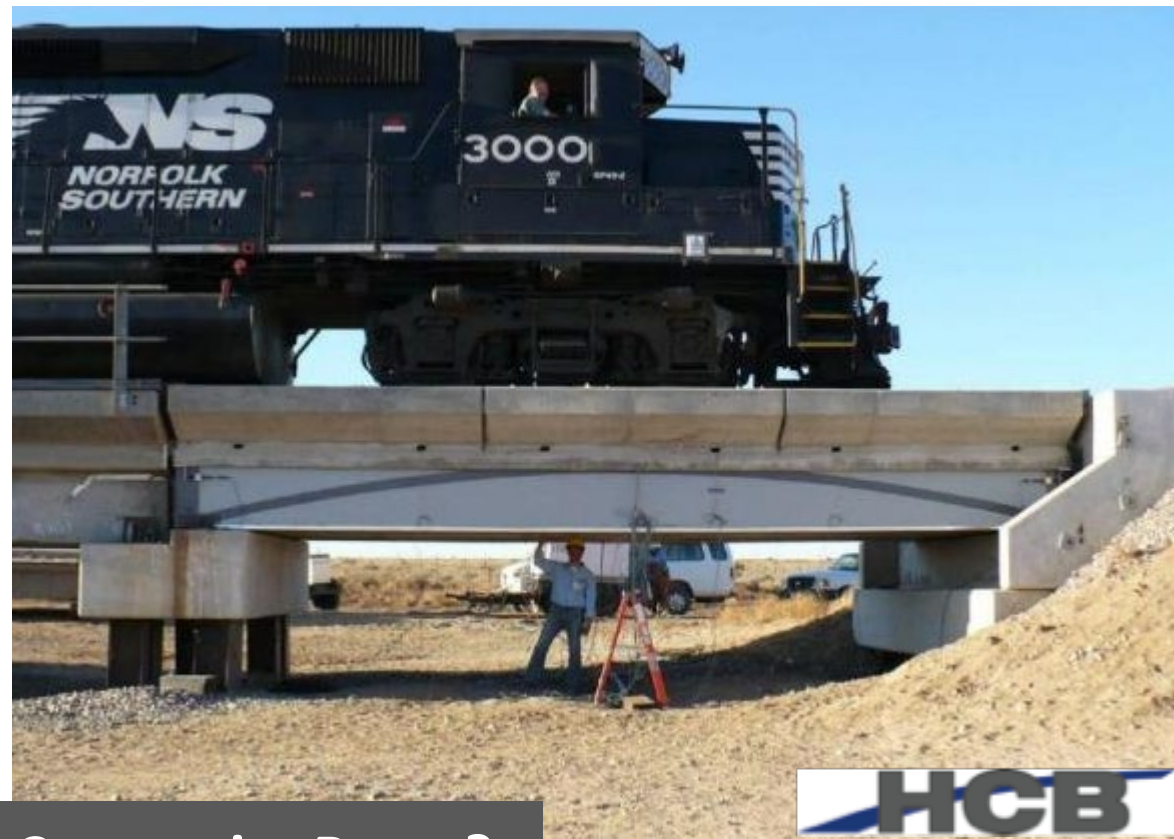
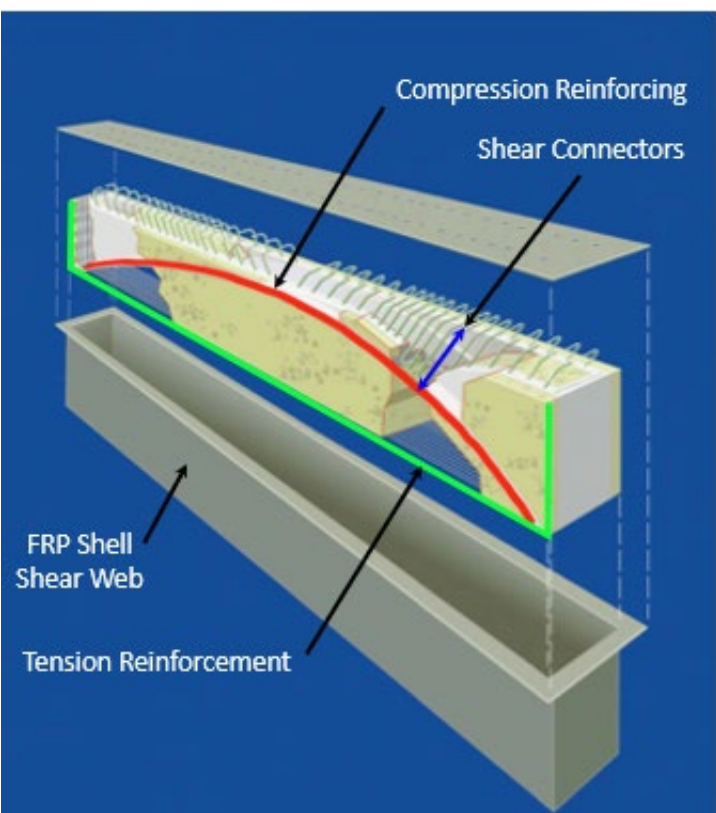

What is a Hybrid Composite Beam?

A structural member using different building materials resulting in a cost effective composite beam designed to be stronger, lighter and more corrosion resistant





- University of Maine Research Pier, Machias, ME
- 30.5 m 3-span w/460 mm - Sept 2011

- High Road Bridge - Lockport Township, IL
- 17.4 m Span - August, 2008



Design Considerations

What are Architect's and Engineer's Expectations

- **Fire Performance Compliance**
- **Structural Compliance**
- **Weight Compliance**
- **Thermal Insulation**
- **RF Transparency**
- **Acoustic Absorption**
- **Environmental Impact**
- **Safety of Production and Installation**
- **Recyclability**
- **Durability and Longevity**
- **Initial and Life Cycle Cost.**



Review of Fire Compliance with modern Composites.



FIRE RESISTANCE FRP COMPOSITES MEET VERY HIGH FIRE SPECIFICATIONS

FRP can be made **flame retardant** or **self extinguishing** with **low smoke** emission. Unlike thermoplastics, BFG's FRP which are Thermoset do not drip or melt.

Today, BFG has the largest database in world and provide compliance to British, European and American standards.

Fire Performance Criteria

Fire safety performance of composite materials

- Composites are by their nature inherently fire resistant. The inert fiber reinforcement which is major constituent does not burn. The resin which is the polymer base, can be tailored to be self-extinguishing with new advancements in chemistry & formulations.
- With the appropriate choice of resin, additive and fillers, Fibre Reinforced Plastic (FRP) materials can be used to make structures with outstanding fire performance compared to other organic materials.

Criteria to assess fire risk in Composite

Fire reaction - this characterizes the performance of the material based on:

- Fire propagation over time - Flame spread;
- Evaluation of compartment fire growth based on the calorific value attached to the material -- Heat Release Rate (HRR)
- Quantity & time within which smoke is generated – Smoke opacity & toxicity
- Ability of the material to melt & affect other areas – Falling drops

Fire Specifications & Testing

What do the codes normally specify as assessment standards?

Depending on the geographical region, assessment is based on end use application as differentiated ahead

1. Internal/ External panels or structures are expected to meet one of the following:

- British BS476 part 6 & 7,
- American ASTM E 84
- NFPA 268 / 286,
- NFPA 285
- European EN 13501, EN 13823
- German DIN 4102
- ISO 5660

2. Roofing scopes are generally tested as an assembly based on associated standards such as

- CEN– TS-1187
- ASTM E 108
- BS476 part 3.
- EN 13501-5

These tests include a fire penetration test as a major assessment tool with respect to safety

3. Loadbearing structures - Another element of fire safety focuses on Fire Resistance which judges the ability of the component to withstand the effects of fire based on:

- Resistance to collapse, i.e. the ability to maintain loadbearing capacity (which applies to loadbearing elements only).
- Resistance to fire penetration, i.e. an ability to maintain the integrity of the element.
- Resistance to the transfer of excessive heat, i.e. an ability to provide insulation from high temperatures.

It is generally assessed based on the following building standards

- ASTM E 119
- BS476 part 20– 24
- EN 13501

COMPOSITE CLADDINGS AND PANELS FOR THE LONDON UNDERGROUND STATION INFRASTRUCTURE RENOVATION



Test Method	Parameter	Category 1A	BFG SYSTEM
BS 476-6	1	<6.0	0.2
	1	<12.0	9.0
BS 476-7	Surface Spread of flame (worst permissible class)	Class1	Class1 (no flame)
Annex D Sample group test	Ao ON	<2.6	2.2
		<3.9	3.2
Annex B Toxicity	R (max)	<1.0	0.80 NFX 70-100
Annex B Toxicity	R (max)	<1.0	0.14 prEN 2824 (200 phr ON 921)

Frequency Hz	Coefficient of Acoustic Absorption					
	125	250	500	1000	2000	4000
Composite Only	0.02	0.06	0.06	0.06	0.04	0.00
BFG Station Panels	0.19	0.21	0.49	0.58	0.47	0.51

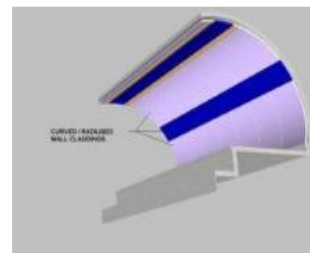

- ▶ Fully Fire Compliant to London Underground Standards
- ▶ High Coefficient of Acoustic Absorption without Apertures
- ▶ Very High Durability and Cost Economy
- ▶ RF Transparent



NFPA 285 Study

Fire Test Method for Evaluation of Fire Propagation Characteristics of Exterior Wall Assemblies Containing Combustible Components

- ✓ Test method explained
 - ✓ Visualization of BFG's PANEL PERFORMANCE
- 

NFPA 285 - Background

- NFPA 285 testing provides a method of determining the flammability characteristics of exterior, non-load-bearing wall assemblies/panels that contain foam plastic insulation.
- The test method described is intended to evaluate the inclusion of combustible component within wall assemblies/panels that are required to be of noncombustible construction.
- It is intended to simulate the multistory flammability fire performance of entire exterior wall assemblies.

NFPA 285 – test assembly & evaluation

- The NFPA 285-2006 testing apparatus is a two-story wall assembly that includes a framed window opening on the first floor.
- The source of ignition or burners are kept alight for 30 minutes .
- The pass/fail criteria are:
 - ✓ That flame propagation does not occur either vertically or laterally beyond an acceptable distance from the area of flame plume impingement on or within the wall assembly. (Extent of burning & flame spread to the 2nd floor level assessed).
 - ✓ Thermocouples are placed throughout the wall and the defined temperature limits cannot be exceeded, otherwise the test is considered a failure.

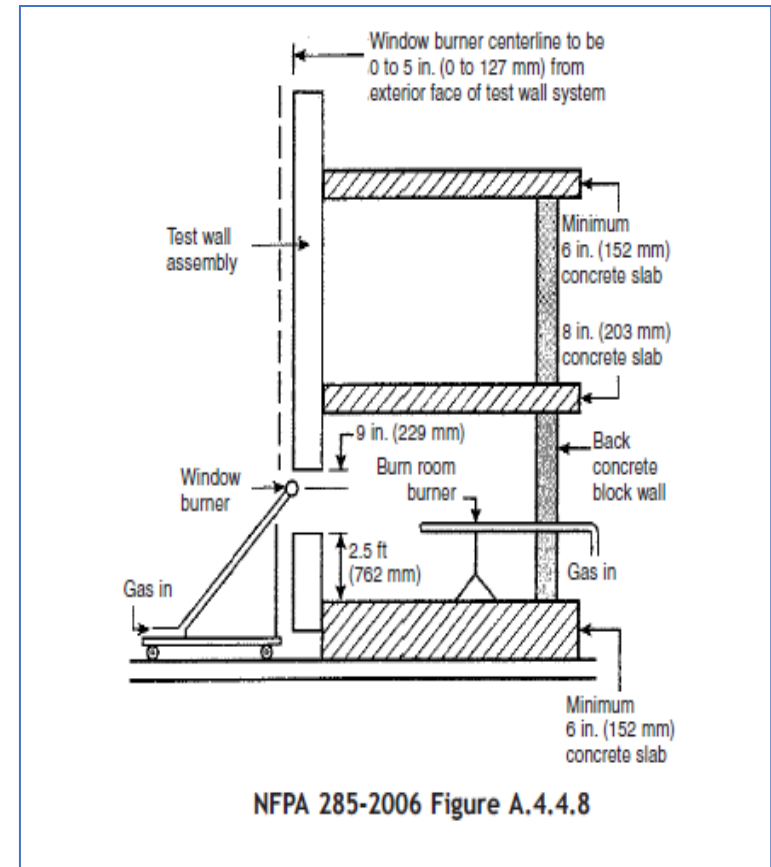

Visual timeline & performance of tests on BFG's FRP panel

CONSTRUCTION TYPE: BFG COMPOSITE SANDWICH PANEL

- Set up ready – Day 0



- Test starts at 9:50 hrs – Day 1



Visual timeline & performance of tests on BFG's panel

- Test progress at 9:55 hrs – Day 1.
 - After 5 minutes



- Test progress at 10:02 hrs – Day 1.
 - After 12 minutes



Visual timeline & performance of tests on BFG's panel

- Test progress at 10 :19 hrs
 - After 30 minutes



Test progress at 10:26 hrs

(Ignition source PUT OFF)

- After 5 minutes



Performance Analysis of tests on BFG's panel



Panel integrity intact

30:00	The burners were extinguished, the observation period began; There was smoke and some small flames on the assembly
33:00	The flames had self extinguished but smoke continued at the assembly
40:00	The test was terminated

Flames on the exterior panels were within the established limit during the test (10' above the top of the window, 5' beyond the side of the window); there were no flames that spread through the core components or infiltrated the second story room; none of the thermocouples exceeded their maximum limits.

Performance Analysis of tests on BFG's panel -- Side view

Observation : No flames spread to the next level -- structural assembly totally intact.



CERTIFIED TO NFPA 285 COMPLIANCE



6 Conclusion

Intertek Testing Services NA, Inc. (Intertek) has conducted testing for Permasteelisa Gartner Middle East LLC, on their GRP Panels over galvanized steel sheets, to evaluate the panels' fire resistance. Testing was conducted in accordance with the applicable requirements of, and following the standard methods of, **NFPA 285 Standard Test Method for Evaluation of Fire Propagation Characteristics of Exterior Non-Load-Bearing Wall Assemblies Containing Combustible Components, 2012 Edition**. This evaluation took place on July 28, 2014.

Based on the data from this test, the assembly met the conditions of acceptance of the above mentioned standards.



Review of Structural Durability with Modern Composites



Structural Durability

Start with Micro mechanics

When a new combination of Fiber and Matrix is being considered, first step is to use the properties of constituent materials to predict the properties of a single layer made of this combination at Fiber Resin interface – Micromechanics

This is based on basic mechanics principles.

Inputs: Enter desired units, "Msi" or "Gpa": **Gpa**

Fiber Properties	E-glass	Resin Properties	Polyester
Fiber Longitudinal Modulus, E1F =	70.00 Gpa	Matrix Young's Modulus, E _M =	3.5 Gpa
Fiber Transverse Modulus, E2F =	70.00 Gpa	Matrix Shear Modulus, G _{12M} =	1.2 Gpa
Fiber Shear Modulus, G12F =	27.00 Gpa	Matrix density, ρ _M =	1.20E+03 kg/m3
Fiber density, ρ _F =	2.54E+03 kg/m3	Matrix Poisson's Ratio, ν _M =	0.35
Fiber Areal Weight, FAW =	1.00E+03 gsm	^{3 per Hysol data sheet}	
Fiber Poisson's Ratio, nF =	0.3	Laminate Properties	
		Resin Content by weight, RC =	0.3500
		Void Volume, VV =	0.02

Fiber Poisson's Ratio, r 0.3
Fiber Volume

$$FV = \frac{1 - VV}{1 + \frac{RC}{1 - RC} \cdot \frac{\rho_F}{\rho_M}}$$

Fiber Volume, FV = 0.457999 = 45.80 %

Ply Poisson's Ratio

$$\nu_{12} = \nu_F \cdot FV + \nu_M(1 - FV)$$

Ply Poisson's Ratio, ν₂₁ = 0.327

Ply thickness

$$t_{PLY} = \frac{1}{\frac{\rho_{PLY}(1 - RC)}{FAW}}$$

Ply thickness, T_{PLY} = 0.8596 mm

Ply Shear Modulus

$$G_{12} = \frac{G_{12M} \{G_{12F}(1 + FV) + G_{12M}(1 - FV)\}}{G_{12F}(1 - FV) + G_{12M}(1 + FV)}$$

Ply Shear Modulus, G₁₂ = 3.14 Gpa

Ply Longitudinal Modulus

$$E_1 = E_{1F} \cdot FV + E_M(1 - FV)$$

Ply Longitudinal Modulus, E₁ = 33.96

Ply Transverse Modulus

$$E_2 = \frac{E_M \left[1 + \frac{(E_{2F} / E_M - 1) FV}{(E_{2F} / E_M + 1)} \right]}{\frac{(E_{2F} / E_M - 1)}{(E_{2F} / E_M + 1)}}$$

Ply Transverse Modulus, E₂ = 5.47

Ply density

$$\rho_{ply} = \frac{1 - VV}{\frac{1 - RC}{\rho_F} + \frac{RC}{\rho_M}}$$

Ply density, ρ_{ply} = 1.79E+03

	E-glass	Polyester
E ₁ :	33.96	Gpa
E ₂ :	5.47	Gpa
G ₁₂ :	3.14	Gpa
ν ₂₁ :	0.327	

Structural Analysis of Composites

The next step is Validation of Micromechanics predicted Data with Material Characterization by testing the combination of Fiber and Matrix. The test include parameters as below. Such validated data is then further used in Finite Element Analysis of actual Composite Structures.

Physical Properties

- **Specific Gravity**
- **Ply/Laminate Thickness**

Mechanical Properties

- **Elastic Properties (E_1 , E_2 and G_{12})**
- **Tensile Strength & Modulus**
- **Compressive Strength & Modulus**
- **Flexural Strength & Modulus**
- **Core Shear Strength & Modulus**
- **Interlaminar Shear Strength**

- ASTM D638: Tensile Properties
- ASTM D695, ASTM D3410: Compressive Properties
- ASTM D790: Flexural Properties
- ASTM D3846, ASTM D732, ASTM D3914: Interlaminar Shear Strength and In-plane Shear Strength
- ASTM D256, ASTM D1822: Charpy/Izod Impact Test
- ASTM D2583: Indentation Hardness by Barcol Impresser

Structural Analysis of Composite Products using FEA

Boardwalk 12m span, 60 kPa Design load

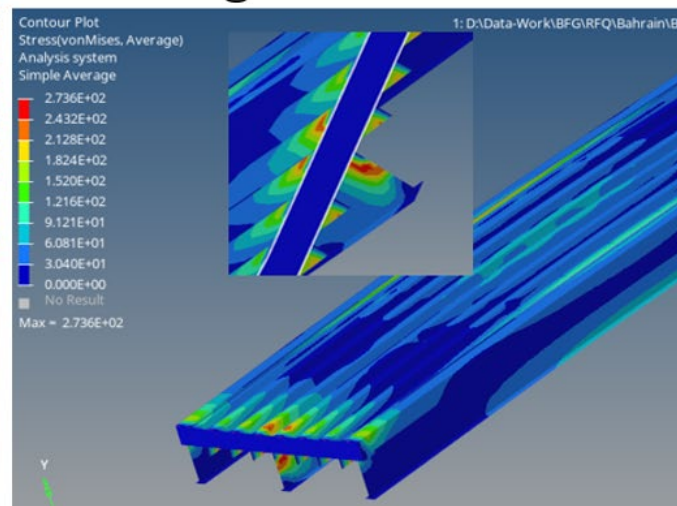
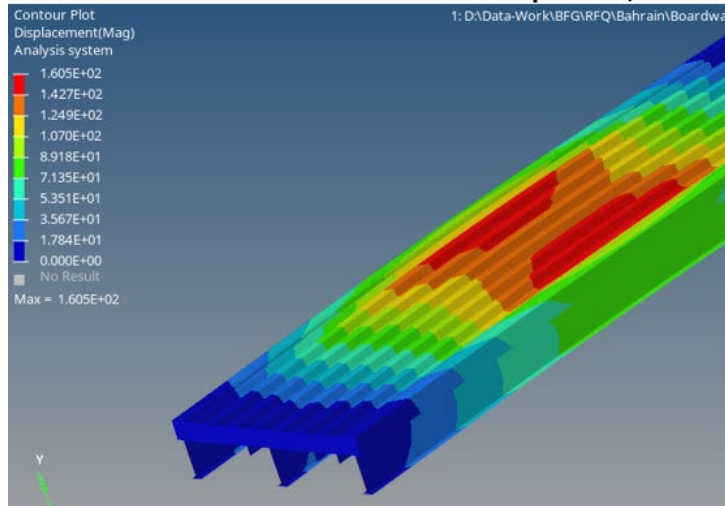

FE Model with true layered Composite Elements for understanding of interlaminar behavior

DISPLAY III - GEOMETRY MODELING SYSTEM - P.O.O. PRE/POST MODEL

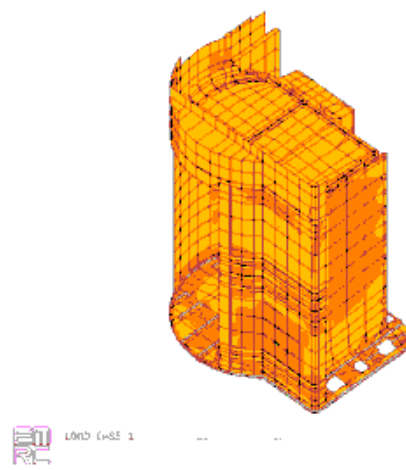

SO-LAYER STRESS

VIEW : 393502,
RANGE: 2190073.



DISPLAY III - GEOMETRY MODELING SYSTEM (31.0/0) PRE/POST MODEL



RESULTANT DEPL.

VIEW : 0.0
RANGE: 0.0482604

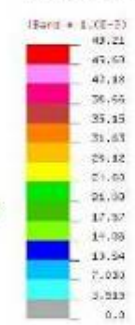

Support Predictions with Physical Testing Validation

Basra Stadium Structural Panels 1.8 kPa Load Test for Deflections

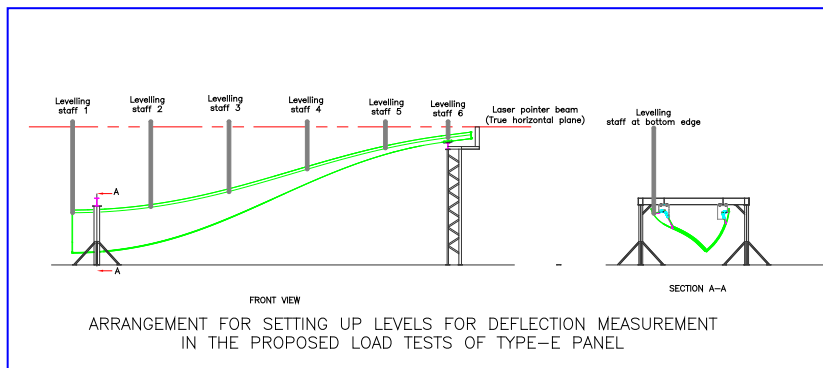
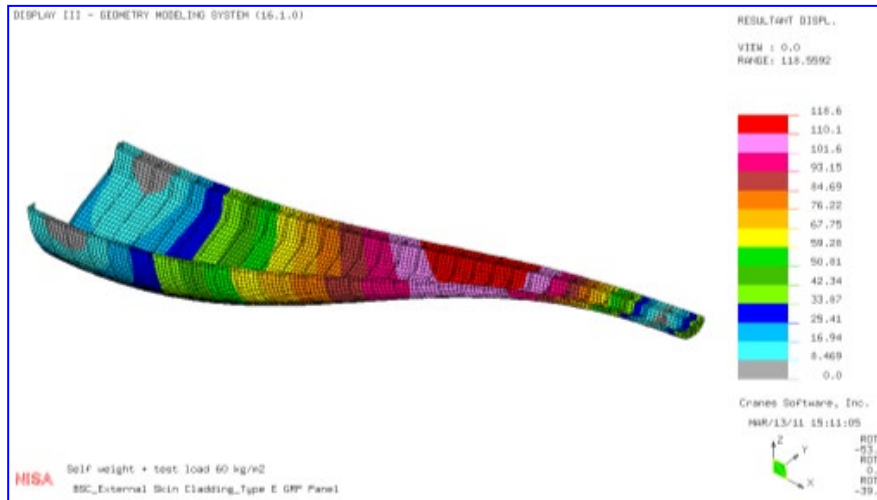

Maximum Deflection = 118.6 mm < 120 mm

Predicted

FRP Composites Offer Excellent Impact Resistance

- ❑ Composites exhibit very good Impact absorption capabilities
- ❑ Composites are resilient materials that do not dent.
- ❑ Ideal therefore for use in high traffic environments
- ❑ Impact Resistance can be validated by physical testing

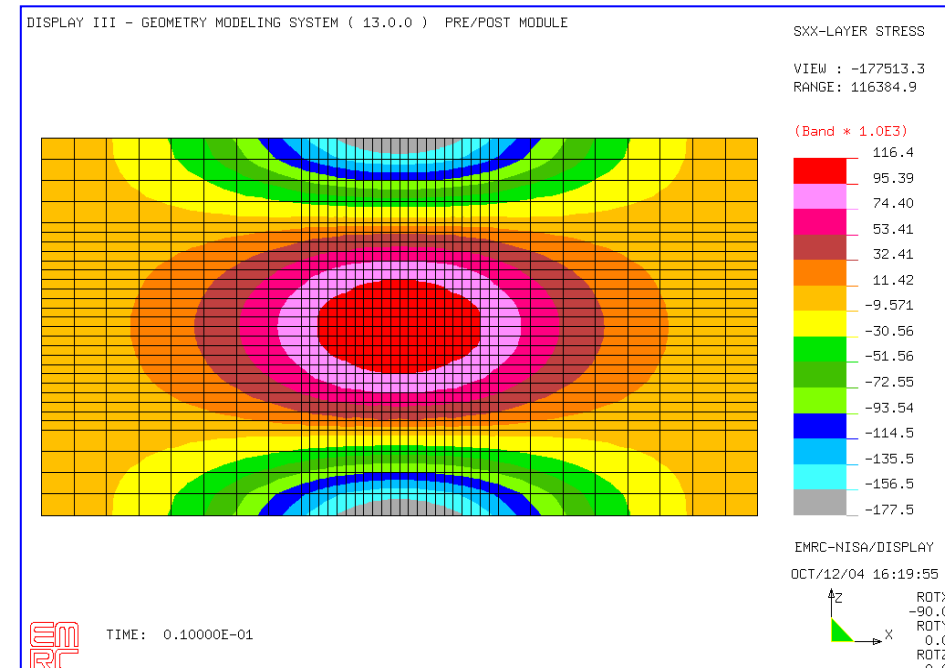
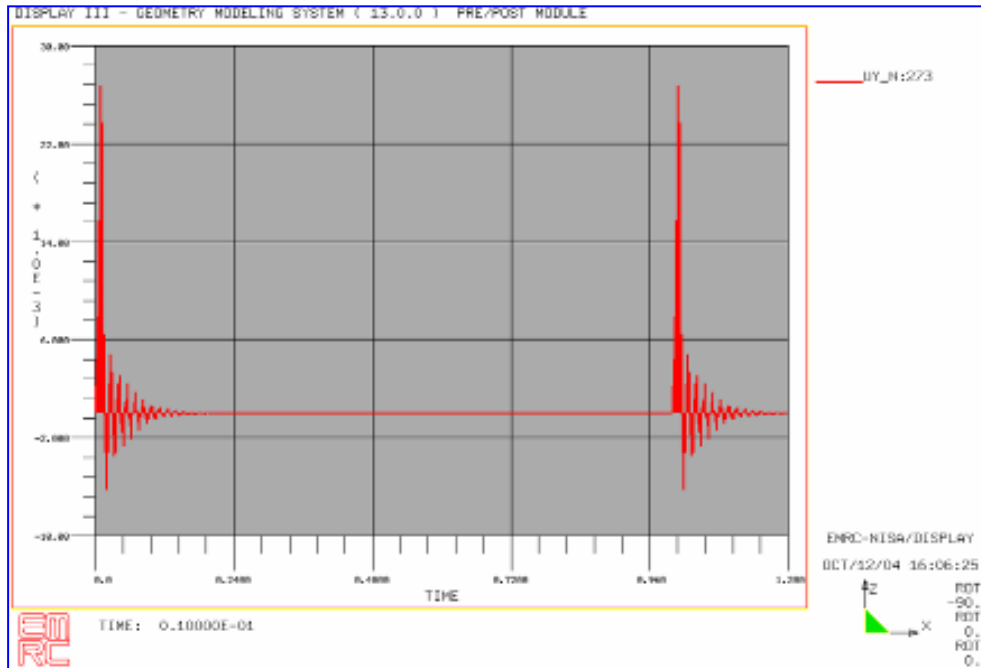

FRP Composites Offer Excellent Weathering Durability

- ❑ Proven Durability in excess of 50 years
- ❑ Accelerated testing predicts composite part life beyond 100 years with a minimal drop in mechanical properties

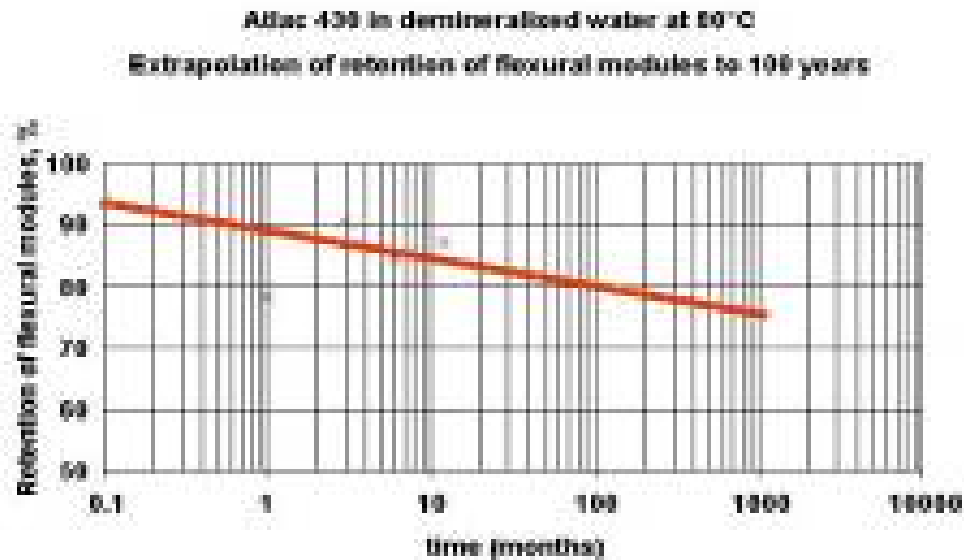



Review of Safety with Modern Composites

- FRP architectural elements are inherently safer than materials such as pre-cast or steel in both handling and application
- Higher strength to weight ratio means architectural elements are lighter in weight than traditional materials such as steel and concrete
- Lighter weight means greatly reduced transportation loads
- Easier to install using lighter weight, non specialist equipment. Typical 3m x 3m modular building element in FRP may weigh 130-200kg. The same product in 220mm pre-cast could weigh circa 3000 kg and require specialist heavy lifting equipment to position with inherent safety implications
- Flexural properties of FRP reduce susceptibility for failure under extreme load or movement. Pre-cast elements can fracture causing embedded brackets and fixings to fail.
- Unlike either pre-cast or steel, FRP is a non-porous, highly durable material extremely resistant to corrosion or degradation in even the harshest environments. This greatly reduces risk of failure.
- Larger, long span panel size means fewer elements to install, using fewer site operatives reducing work at height risk exposure



In June 2018, a six tonne pre-cast concrete wall panel fell from the seventh floor of a building under construction in Australia. The cause was concrete fracture around embedded bracket.



Pre-cast panel failure following seismic activity

Safety- typical causes of failure in pre-cast panels

Cause	Failure mode	Period
Freeze/thaw	Wide defects in exterior surface; delamination and fracture	After one or more winters
Corrosion of reinforcement	Fractures around reinforcement bar zone	Typically more than two years
Alkali Reaction	'Map' type pattern cracks parallel to joints or edges	Typically over 5 years but may be much sooner with highly reactive aggregate
Sulphate attack	Irregular pattern cracks	One to five years

Safety- typical causes of failure in pre-cast panels



Freeze/thaw
due to water
ingress



Chloride
induced
corrosion



Carbonation



Review of Sustainability with Modern Composites

Energy and Environmental Benefits of Composites

- **LEED Certification and the awarding of credits, is based on the overall project design and the performance of the project as a whole. Architectural Glass Reinforced Polymer (Composites) products as a component of the building assemblies can contribute to LEED credit awarding within different categories.**
- **FRP materials have reduced ecological and carbon footprints. This is because being lighter the overall requirement of material & resources is lower compared to traditional building materials.**
- **FRP is a green, energy efficient choice of construction material due to the low total energy required to produce it from the raw materials stage all the way to the product delivery.**
- **Glass, the main ingredient of fiberglass, is made from sand which is a natural, non-depleting resource making fiberglass a sustainable choice. Other environmentally friendly types of reinforcement such as Basalt Fiber or Natural Fibers can also be considered.**
- **FRP products have long life cycles as determined by Life Cycle Assessment (LCA) studies. this translate in to lower environmental impact for their production and construction compared with other traditional materials. Lighter weight also helps in lower operational & resource requirement.**
- **Fiberglass is a durable, low maintenance and long-lasting material. This reduces the need for replacement, repair and repainting. The durable nature of fiberglass makes it a viable earth friendly construction material. Fiberglass materials are unaffected by termites which prevents all the damages caused by termites and other insect. Also there will not be any need for using toxic pesticides.**

How do FRP composites contribute to a Sustainable Future ?

Modern Composites Developers offer sustainable products over an umbrella spanning **THREE DIMENSIONS** within entire **VALUE CHAIN**

- ❖ **Society** – enhancing safety in production, use or end of service life, stakeholder perception of solutions
- ❖ **Environment** – ensuring standards are met, developing environmentally sound solutions
- ❖ **Economy** – potential asset ownership cost savings using Composites.

Focus is then on mapping the benefits FRP composites bring to these three dimensions and how it can help contribute to a sustainable development.

Sustainability Drivers & Mapping

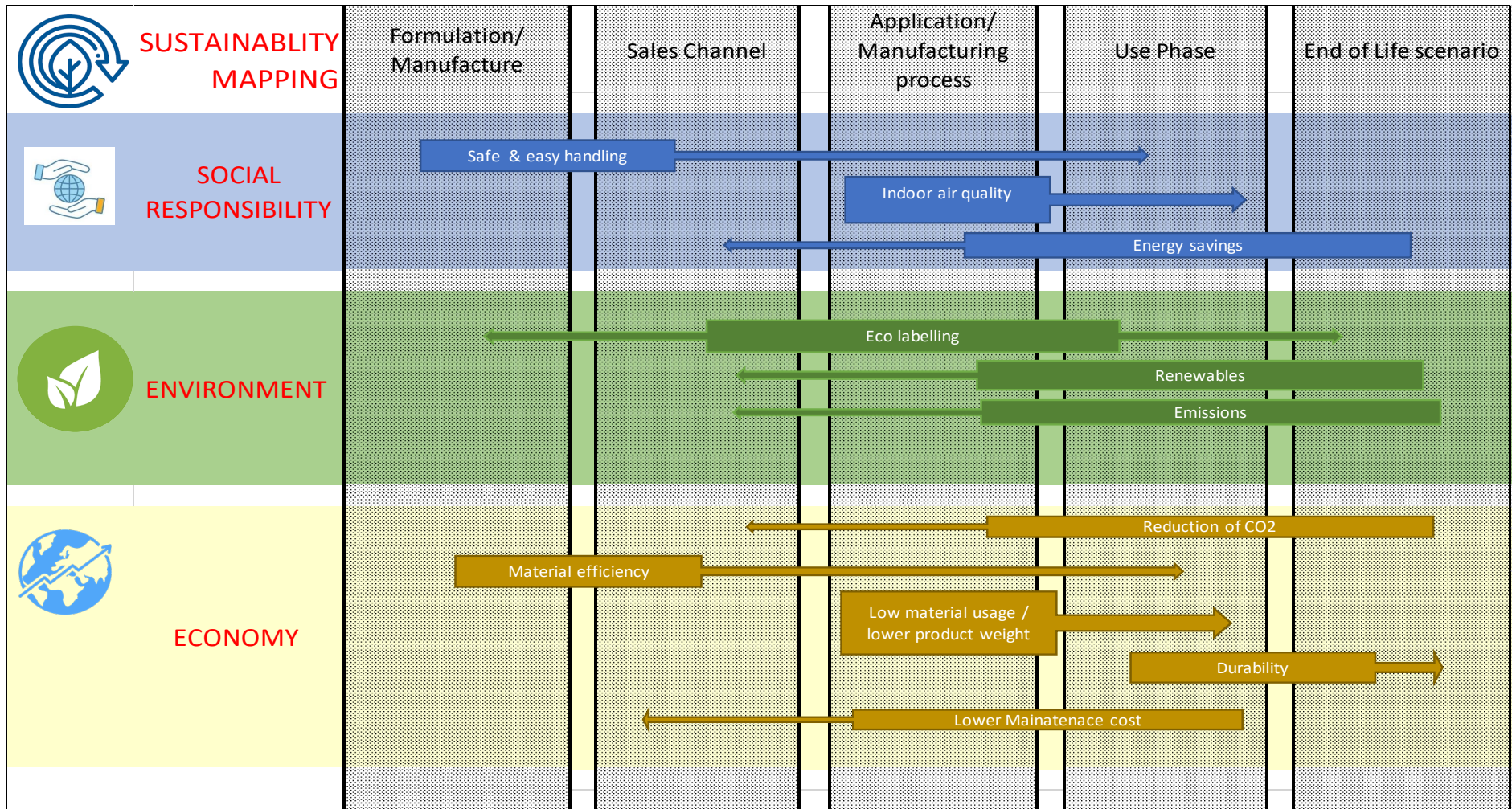

FRP Composites & Social Responsibility

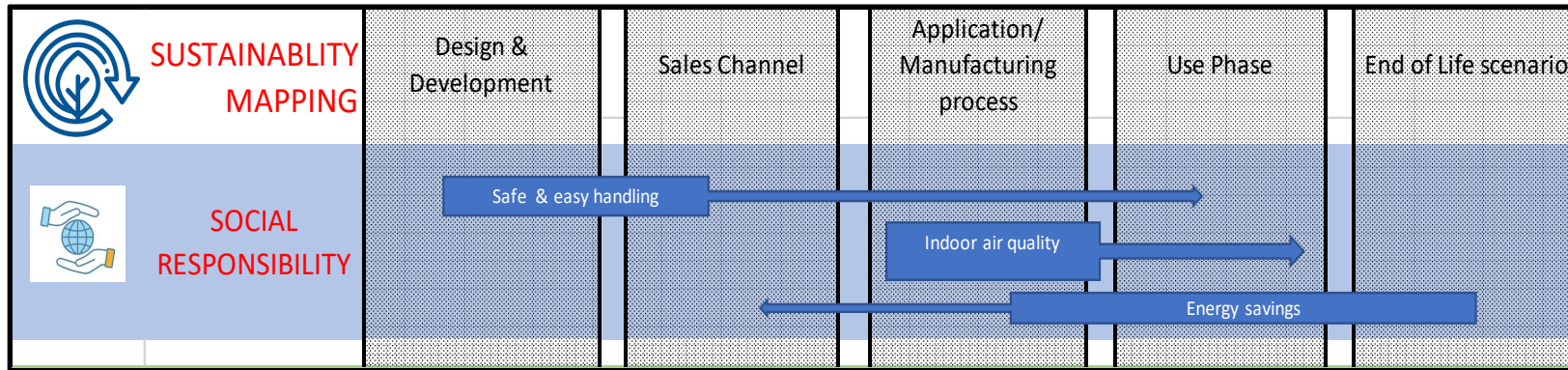

Safe & easy handling

Contribute as a manufacturer :

- ✓ Design & engineer light weight & innovative products, with the highest strength to weight ratio.

How & what does the asset gain:

- ✓ FRP being a lightweight product, needs lower resources for transportation/ assembly .
- ✓ It needs much less support structures and secondary operations for giving the same functional and aesthetic impact.
- ✓ Light weight products also offer lower safety risks.

Indoor air quality

Contribute as a manufacturer :

- ✓ On the manufacturing front -- Adapt closed mould technologies, which help contain VOC's and contribute to the overall working environment.

How & what does the asset gain :

- ✓ The product as supplied also does not emit and harmful VOC's or toxic fumes such as formaldehyde /CFC's etc. and can be considered totally benign .

Energy Savings

Contribute as a manufacturer :

- ✓ ISO 14001 & ISO 18001 certification and adapt the policy within the vision.
- ✓ Source Raw materials regionally, to reduce transport intensive energy resources.

How & what does the asset gain :

- ✓ Product provides inherent thermal insulation; This reduces the building energy demand and improves the indoor thermal comfort.
- ✓ Relatively thin FRP skin allows designers to maximize the amount of extra insulation used in the building envelope.

FRP Composites & the Environment

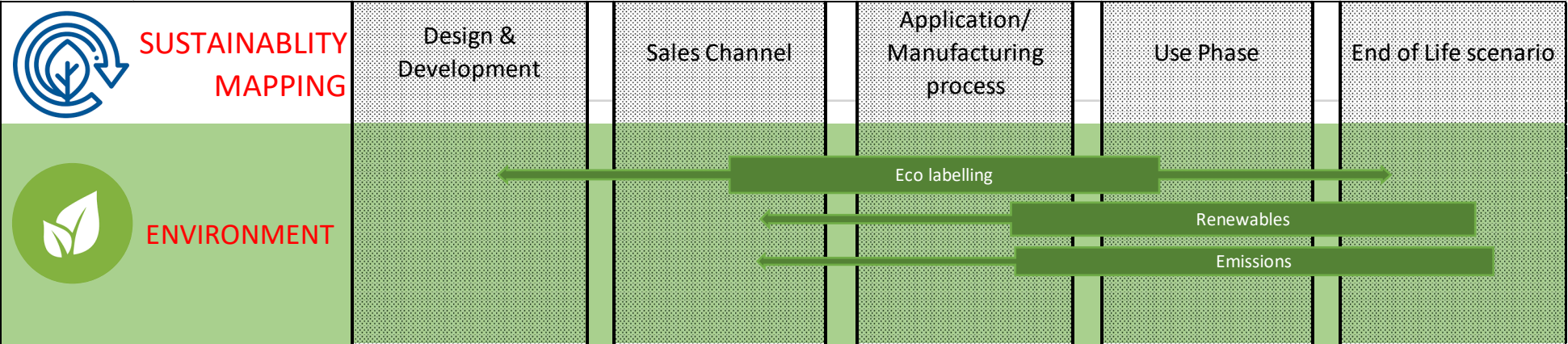

Eco labelling

Contribute as a manufacturer :

- ✓ Label each panel , with a nomenclature giving guidelines on recyclability based on the International standard ISO 11469.
- ✓ Use raw materials compliant to REACH & RESPONSIBLE CARE regulations

How & what does the asset gain:

- ✓ During an end-of-life scenario, a ready reference is available for subsequent decisions concerning handling, waste recovery or disposal.

Renewables

Contribute as a manufacturer :

- ✓ Sandwich construction with green recycled core materials; aligned to the principle reduce, recycle, renew .
- ✓ Glass, the main ingredient of fiberglass, is made from sand which is a natural, non-depleting renewable resource.

How & what does the asset gain:

- ✓ LEED points are awarded for using recycle & renewable materials .
- ✓ At the end of its lifecycle, FRP waste can be shredded and transported to e.g. cement plants to be energetically recycled in a furnace, thus replacing fossil fuels.

Emissions

Contribute as a manufacturer :

- ✓ Adapt closed mould technologies to help contain VOC's and contribute to the overall working environment

How & what does the asset gain :

- ✓ High quality gel-coat finish reduces the need for painting at site and therefore results in lower amount of overall volatile organic compounds (VOC) released.
- ✓ The product as supplied does not emit any VOC.

FRP Composite & Economy

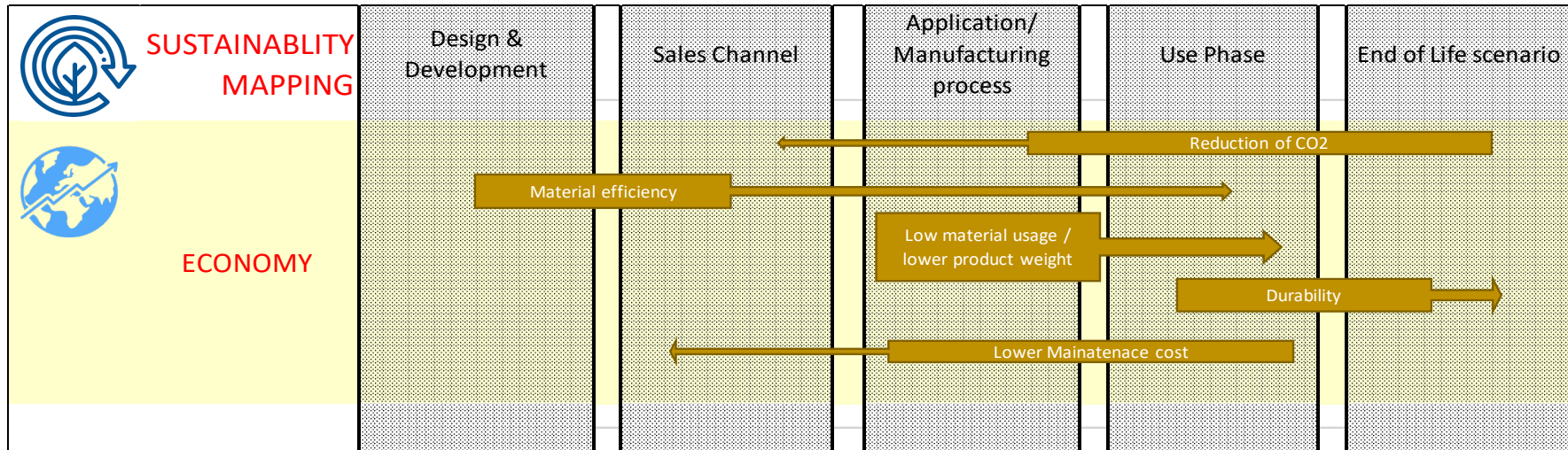

Reduction of CO2

Contribute as a manufacturer:

- ✓ FRP is known for its very low embodied energy. When properly engineered, production of FRP components consumes less energy and produces less greenhouse effect verses recycling steel and aluminum.
(Source : Daniel, Ryszard A., Environmental Considerations to Structural Material Selection for a Bridge. European Bridge Engineering Conference, Rotterdam, March 2003)

How & what does the asset gain:

- ✓ Reduction in the overall energy load earns ENERGY STAR®, contributes to LEED®, Green Globe® ratings

Summary of Total Energy required to produce a product from the raw materials stage

MATERIAL	Consumed energy and energetic material value MJ/kg
Structural steel	46
Recycled structural steel	36
Stainless steel	69
Recycled Stainless steel	54
Composites	33
Aluminium	137
Recycled Aluminium	45

Material Efficiency

Contribute as a manufacturer:

- ✓ Ability to custom design & develop products with optimized materials with directional reinforcements only where needed. Light weight FRP composites needs a much lower support structures reducing overall materials need for the asset.

How & what does the asset gain:

- ✓ Innovative design solutions, less assembly times , lower overall cost . Allows architects and designers freedom to innovate

FRP Composite & Economy

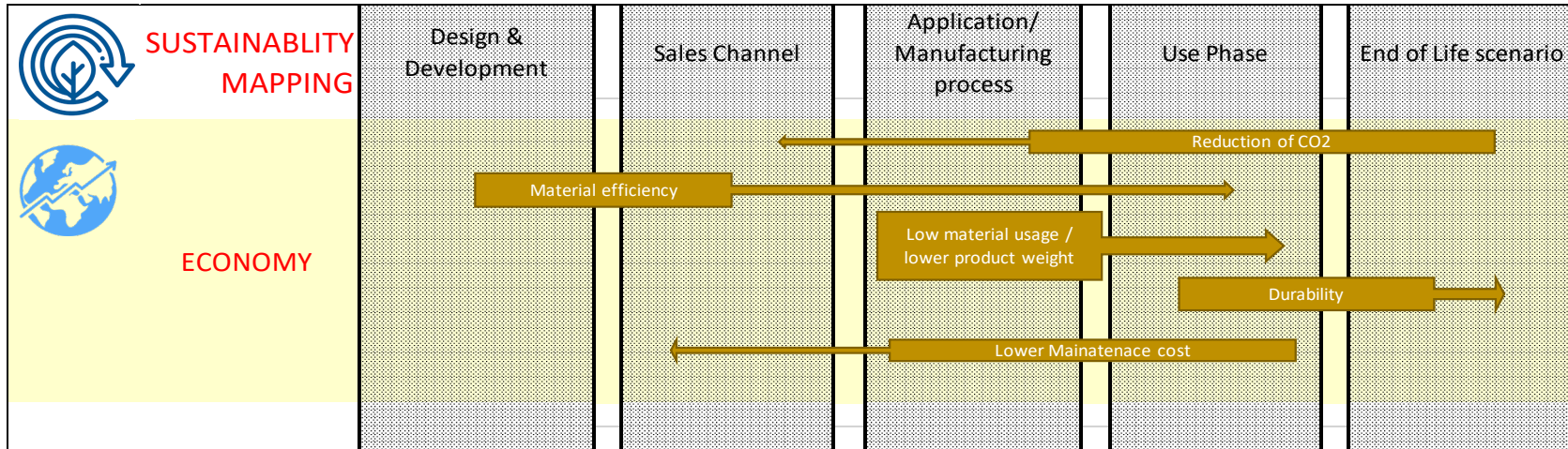

Low material usage/lower product weight

Contribute as a manufacturer:

- ✓ For equal strength, Composites are a lot less material weight at the asset.

How & what does the asset gain:

- ✓ The overall carbon footprint of the asset is lowered, and life cycle costs reduced.

Lower maintenance cost

Contribute as a manufacturer:

- ✓ Composites are corrosion free, easy to maintain and provide thermal & sound insulation.

How & what does the asset gain:

- ✓ Lower asset ownership costs.
- ✓ Easily refurbished in place if needed, without affecting the finish.
- ✓ Longer and more economical service life and require less frequent energy-intensive maintenance and replacement.

Durability

Contribute as a manufacturer:

- ✓ Composites provide structural durability over a lifetime.
- ✓ Composites are fully resistant to environmental and chemical corrosion which makes them ideal for harsh operating conditions & high service temperature.

How & what does the asset gain:

- ✓ Composites have a lifespan of over 50 years, reducing the environmental impact of maintenance and replacement.
- ✓ At the end of its lifecycle, FRP waste can be shredded and transported to e.g. cement plants to be energetically recycled in a furnace, thus replacing fossil fuels.

CASE STUDY - WIND ENERGY SECTOR

Wind turbines deploy large structural FRP Composite elements - Blades/ Nacelles/ Spinners.

The sustainability benefits Composites Bring:

MINIMUM RESOURCE USED

- ✓ Design optimized for precise structural behavior using customized fiber orientation /type.
- ✓ Use of manufacturing process of infusion that provide high strength and stiffness to the product
- ✓ Raw materials sourced from regional suppliers within a radius of 500 km
- ✓ Long service life with minimal maintenance even in aggressive environments on and offshore.

LOW ENVIROMENTAL IMPACT

- ✓ Closed mould processes with lower VOC's.
- ✓ Lower manufacturing waste
- ✓ Increased speed of assembly

HIGHER PERFORMNACE

- ✓ Customized engineered product
- ✓ High stiffness to weight ratio, allows for lesser material for equivalent characteristics.
- ✓ Resistant to the most aggressive environments.

“Wind turbines generate as much energy as was used to build them within merely three to six months.”

(The wind industry in Germany)

Source: <http://www.deutsche-windindustrie.de/fakten/klimaschutz/>



Conclusions

Why Composites for Architecture

1. **LEED Enabling, Studies show that FRP Composites are environmentally friendly, and can support green buildings.**
2. **Innate Durability and Very Long Life**
3. **Easy to install, dismantle, reuse, and relocate**
4. **High Design Flexibility and Customizable Aesthetics**
5. **Lightweight with a very high strength to weight ratio**
6. **Very High Corrosion resistance**
7. **Dimensional Stability. FRP composites maintain their shape and functionality even under severe mechanical and environmental stresses.**
8. **Can be Engineered for Excellent Thermal Insulation**
9. **Can be Engineered for Excellent Fire Performance**
10. **Mouldability, No Complex Joints, curves Integrated into one piece molding, hence no leakages & very low downtime**
11. **No Limitation on Panel Size beyond Transportability**
12. **Site Repairable**
13. **Long term Cost savings, When comparing total installed cost, composites are in most cases the cheaper solution—when looking at total life cycle cost, they are regularly of lower cost.**



CONTACT

BFG International

P.O Box 26197. Mina Salman

Kingdom of Bahrain

T +973 1772 7063

www.bfginternational.com

ideas@bfginternational.com

Mathew Sailesh

+973-36111479

mathew@bfginternational.com

SHAPING THE FUTURE TOGETHER

To shape tomorrow with confidence, start a rewarding dialogue with us. We look forward working with you on your next project.